

Installation and Operations Manual

(229-189)

for the **Panel Automatic Controls**
P/N 29-355 (Flush Panel Automatic Control)
P/N 29-356 (Table-Top Panel Automatic Control)

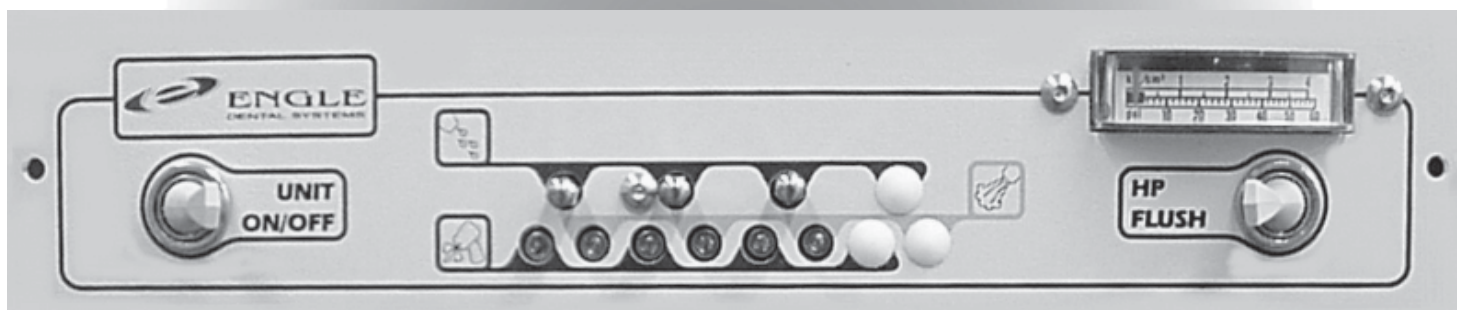



P.O. Box 725 · 4115 24th Avenue Suite A · Forest Grove, Oregon 97116, USA
www.engledental.com

INSTALLATION AND OPERATION MANUAL

Customer Service:

7:00 A.M. to 4:30 P.M. (Pacific Time)
Phone: 800-547-1906
Fax: 503-357-7286
E-mail: info@engledental.com

Technical Support:

7:00 A.M. to 4:00 P.M. (Pacific Time)
Phone: 800-547-1906
Fax: 503-357-7286
E-mail: support@engledental.com

Warranty

Products sold to and installed by authorized Engle Dental Systems dealers are guaranteed against defects in materials and workmanship for a period of five (5) years after date of purchase. Engle 300 dental chair Electronic Positioning Components have a Limited Warranty of ten (10) years after date of purchase. Upholstery is guaranteed for one (1) year after date of purchase. All hand-piece illumination systems are guaranteed for six (6) months after date of purchase. This warranty does not cover light bulbs of any kind.

Faulty parts as determined by dealer service representative, will be repaired or replaced; no claim for labor or consequential damages will be allowed. Invoices for replacement parts may be subject to adjustment after the manufacturer has inspected the alleged defective parts.

The warranty does not cover normal wear, stains, cuts, or scratches of upholstery surface finishes, or parts sold to O.E.M. customers.

This warranty does not cover damage resulting from the use of cleaning, disinfecting, or sterilization chemicals and processes.

The warranty does not cover damage from improper installation or maintenance, accident, misuse, or accidents incurred in shipping and handling.

In the event of shipping damage, the purchaser must initiate all claims against the freight carrier in writing within twenty-four (24) hours after the damaged items are received. The claim is the responsibility of the customer.

PRODUCT MODIFICATIONS

Engle Dental Systems continually works to better our products. We reserve the right to make modifications without notice or obligation to modify previously manufactured products.

CLEANING AND DISINFECTING ENGLE EQUIPMENT

Infection control in the dental office continues to be a high priority for our customers and end users. O.S.H.A., the A.D.A., and the C.D.C. are also involved in this complex issue.

We will not attempt to specify the required intervals for disinfection nor can we state what is the overall best surface disinfectant. Please refer to the Infection Control Recommendations published by the American Dental Association for further reference.

Barrier Technique

ENGLE strongly advocates the barrier technique be used whenever possible to preserve the finish and appearance of the equipment. Wherever possible disposable barriers should be used and changed between patients. The barrier technique will ensure maximum long term durability of the surfaces and finishes of equipment.

Chemical Disinfection

Regardless of the chemical disinfectant used it is imperative that the equipment be thoroughly washed with mild soap and warm water at least once per day. This wash down will minimize the harmful effects of chemical disinfectant residues being allowed to accumulate on the equipment.

When using a chemical disinfectant, always pay strict attention to the manufacturer's application directions of the disinfectant. When using a concentrated disinfectant, always pay strict attention to the manufacturer's diluting directions of the disinfectant. *"Disinfectant solutions that are relatively harmless to surfaces at their recommended strengths can be corrosive at a higher/purer concentrate."*

Unacceptable Disinfectants

These disinfectants **WILL HARM** the surface finishes of ENGLE equipment and are **NOT RECOMMENDED**.
USE OF THESE PRODUCTS WILL VOID YOUR WARRANTY.

CHEMICAL COMPOSITION	TRADE NAMES
Strong Phenols/Phenol-Alcohol Combinations	Lysol, Lysol 2, Lysol Professional Coe Foam, Coe Spray Pump, Vitaphone, Omni II
Sodium Hypochlorite/Household Bleach	Clorox, Ajax, Purex
Alcohol	
Household Cleaners	

Conditionally Acceptable Disinfectants*

These disinfectants have been found to be the LEAST HARMFUL to the equipment surfaces.
None of these products are recommended for chair upholstery. Use the barrier technique.

CHEMICAL COMPOSITION	TRADE NAMES
Iodophors**	Biocide, Aseptic-IDC Wescodyne, SD5, Promedyne, Ido-Five
Mild Phenols	Procide ES, Asepti-Steryl Aerosol
Glutaraldehyde/Phenol sprays	Sterall Spray, Coldspor
Synergized Super Quat	Dis-cide, Cavicide, Kleenaseptic
Phenol/Water Sprays	Top-Cide, Sporicidin Pump Spray, Birex se

* ENGLE DENTAL SYSTEMS makes no representation as to the disinfectant efficacy of these products. We make no warranty, expressed or implied, that these disinfectants will not damage the surface finishes. Damage and discoloration of the surface finishes is not covered under the warranty.

** Iodophor based disinfectants will cause yellow staining on many surfaces. Regular washing with soap and water will minimize this staining. Iodophor neutralizers such as Promedyne are also available.

TOP VIEW

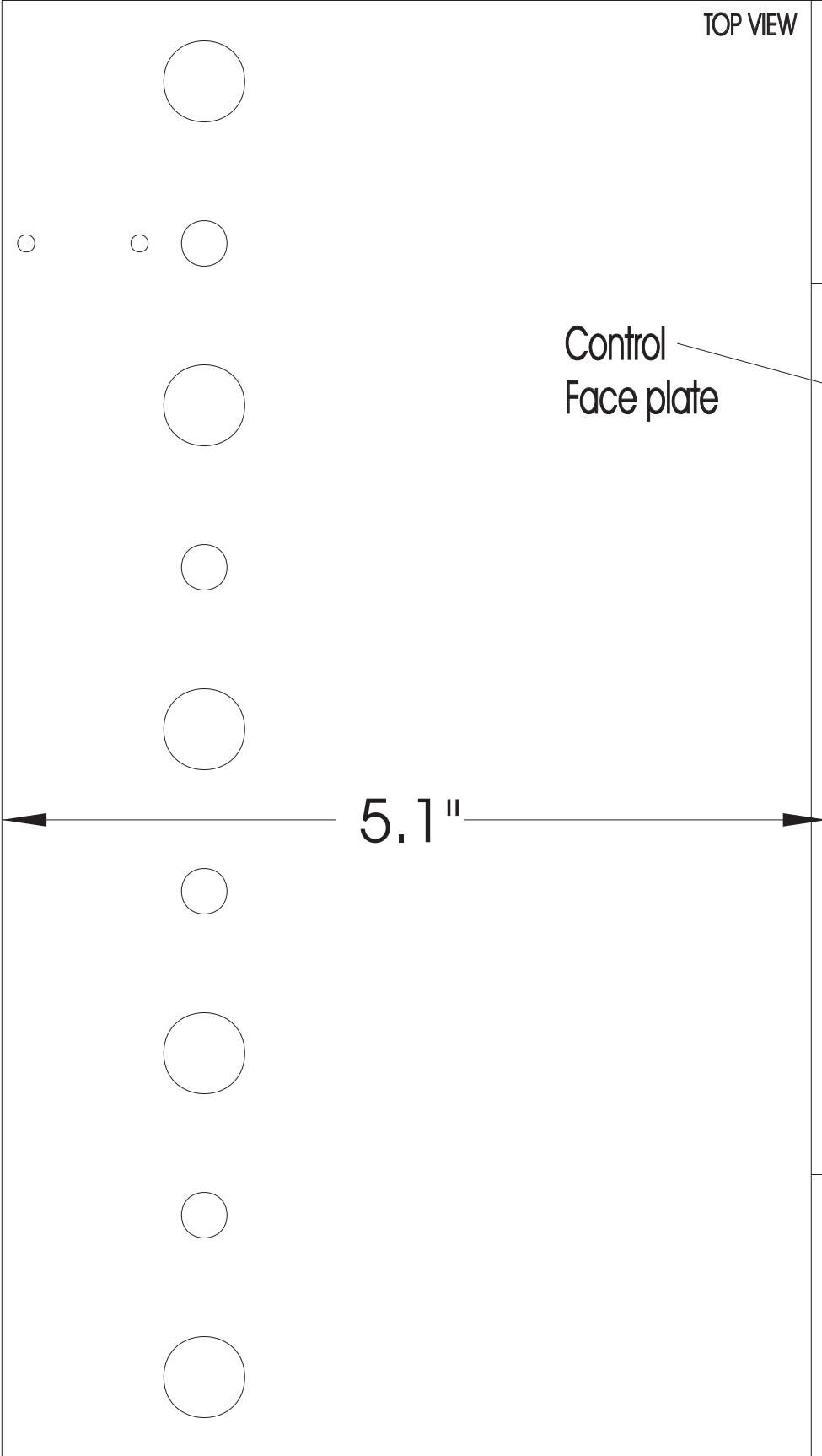

Control
Face plate

FRONT VIEW

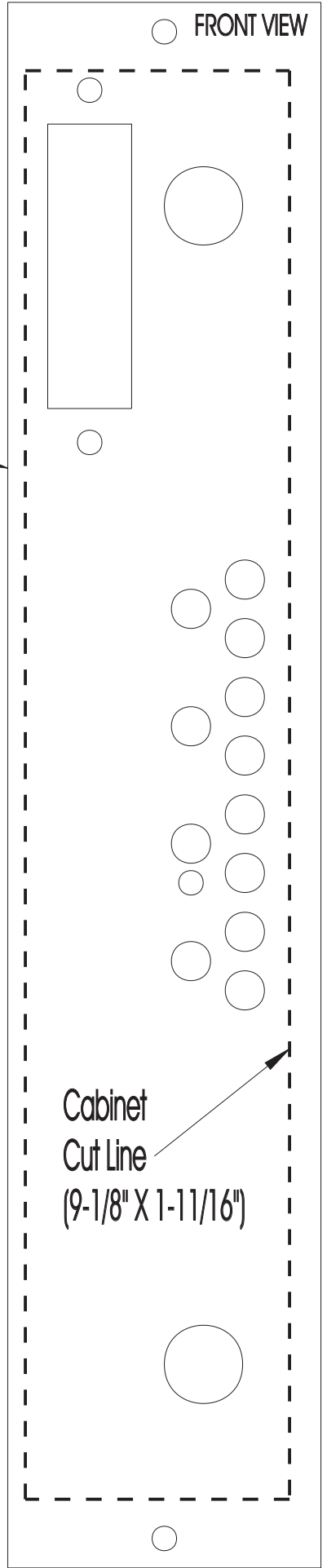

Scale - 1:1

- A) Unit On/Off Switch - Sends air and water to the unit control.
- B) Drive Air Pressure Gauge - Gives air pressure reading for the handpiece in use.
- C) Drive Air Adjustment Screws - Regulates the amount of air pressure to each handpiece. Turning screw clockwise decreases pressure, while turning it counterclockwise increases pressure.
- D) Air Coolant Flow Valve - Delivers air to each handpiece, which changes the flow of water from a stream to a spray.
- E) Water Coolant Flow Valves - Regulates the amount of water to each handpiece, turning knob clockwise decreases flow, while turning it counterclockwise increases flow.

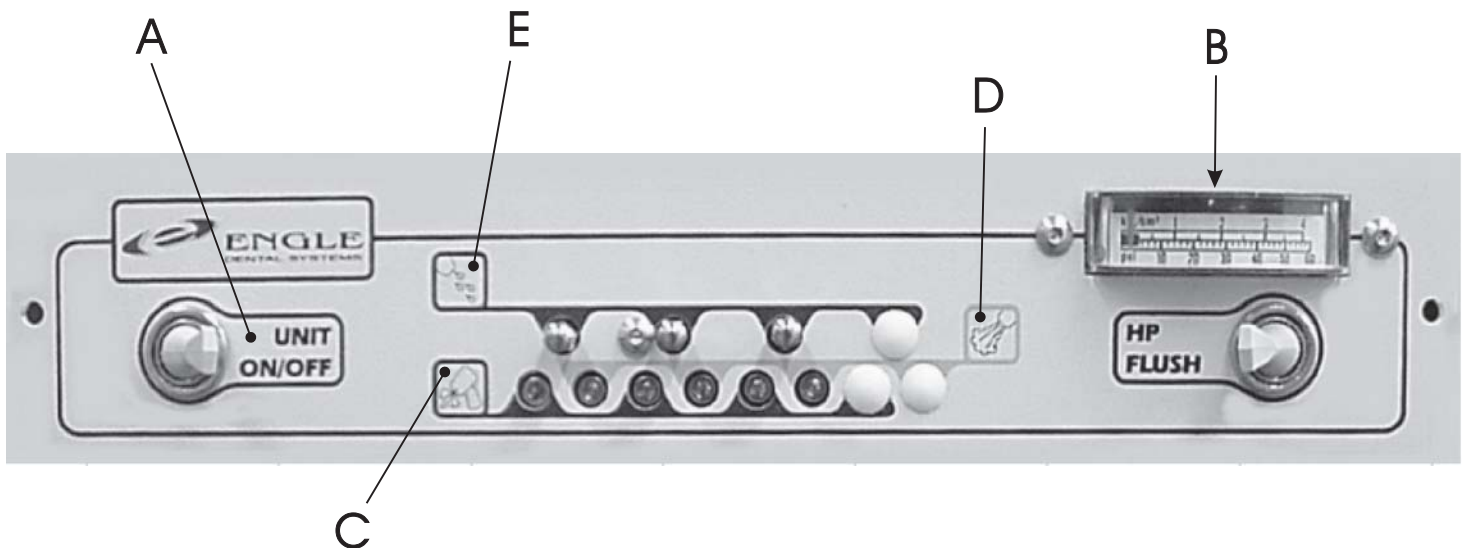

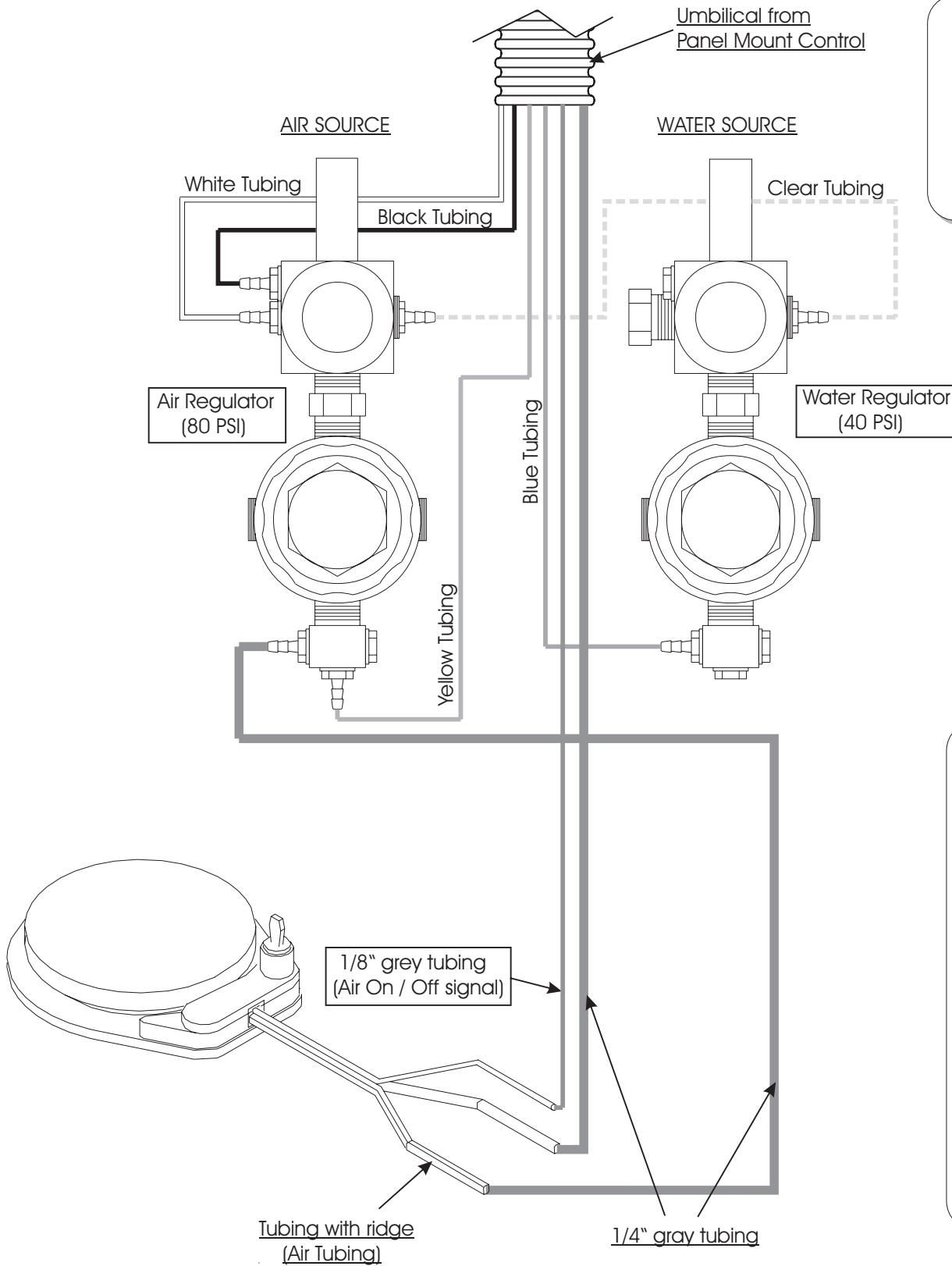

Plumbing for City Water
(See next page for optional Clean Water System plumbing.)

Use quick disconnects to attach like-colored tubings from the regulator and foot control to the umbilical from the panel mount control.

Plumbing for
Clean Water
System

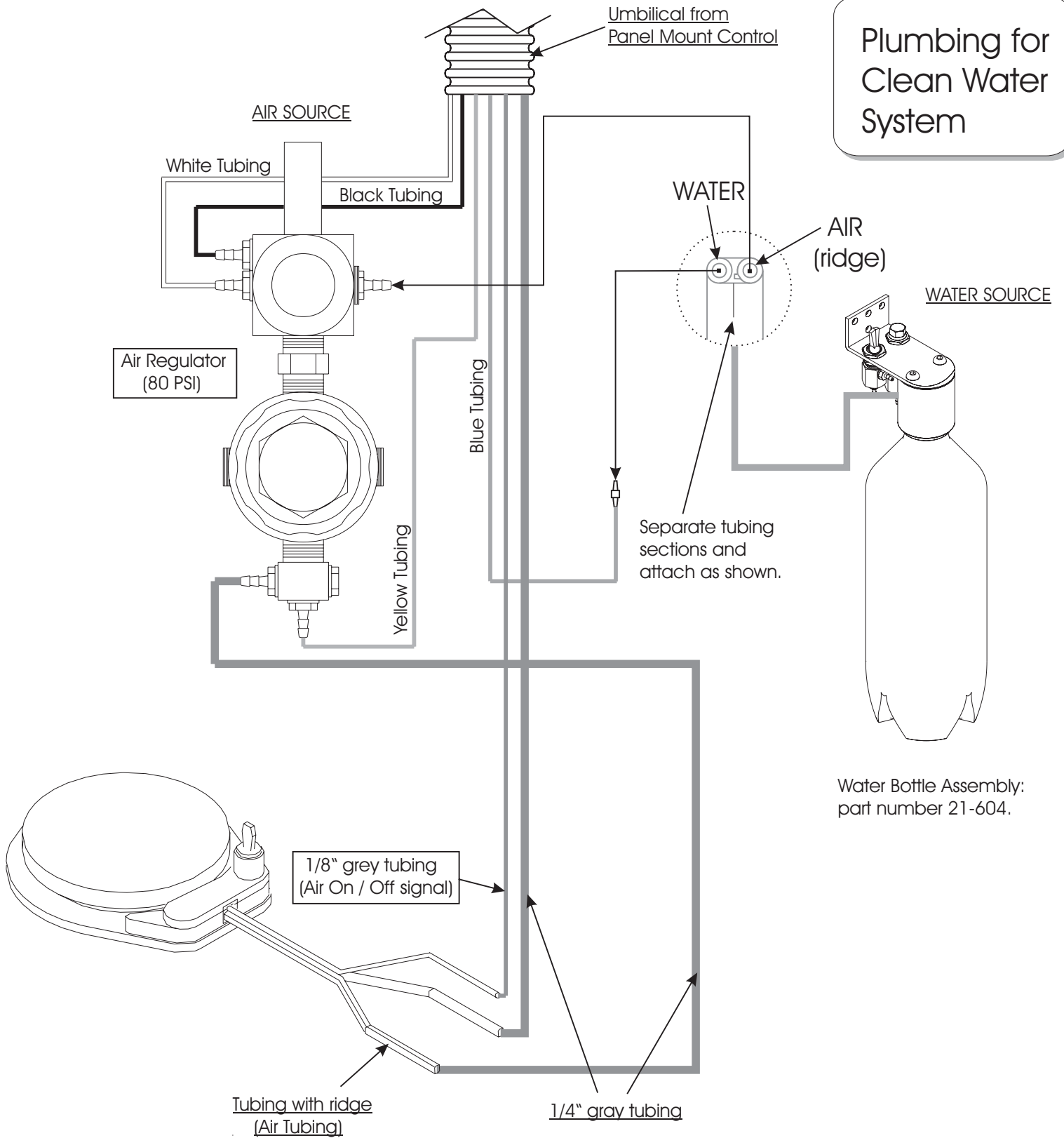

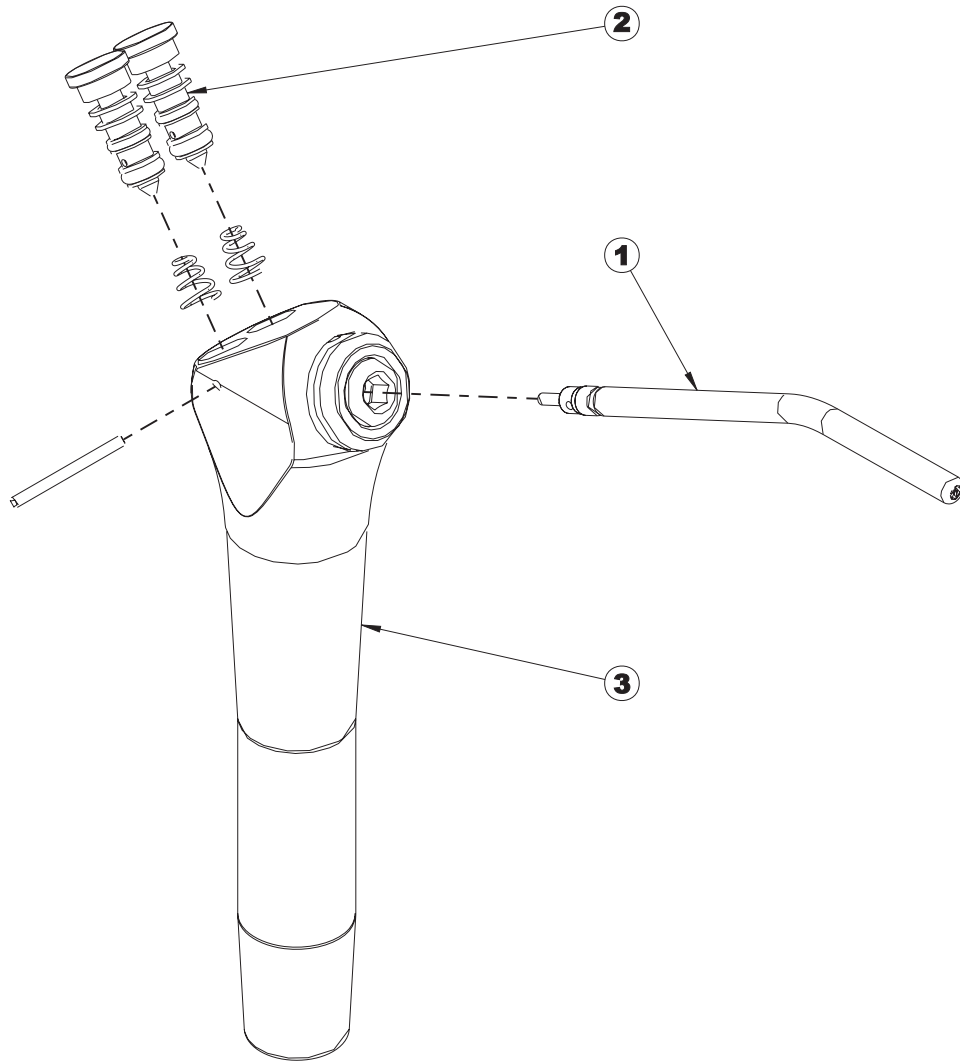

NO.	PART NO.	DESCRIPTION	QTY.
1	20-390	TIP	1
2	20-393	CARTRIDGE ASSEMBLY	2
3	20-395	SYRINGE	1

